

LAPTOP SIDE SHELF

CONNECTS TO CENTRAL ALUMINUM COLUMN

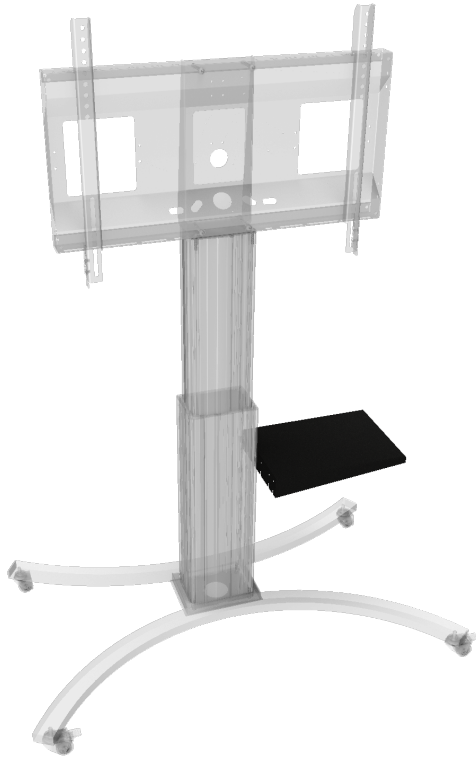

PRODUCT

Side shelf connects to the right and/ or left side of the pylon. Allows for 4 different mounting positions.

FEATURES

- › Compatible with SCETA and SCEXL series
- › Steel plate 2 mm
- › Powder coated in RAL 9005, black
- › Including mounting accessories (4x sliding block with thread, 4x nut with integrated washer)



Display mount



Projector mount



IWB mount



Max. load
10 kg / 22 lbs

Item number	LAP4-SM	
Load capacity	10 kg	22 lbs
Width / Height / Depth	415 mm / 22 mm - 62 mm / 295 mm	16.3" / 0.9" - 2.4" / 11.6"
Weight	2,9 kg	6.4 lbs
Packages	Package dimensions WxHxD	Package weight
LAP4-SM	440 x 90 x 340 mm / 17.3 x 3.5 x 13.4"	3,4 kg / 7.4 lbs

DIMENSIONS

in mm / inch

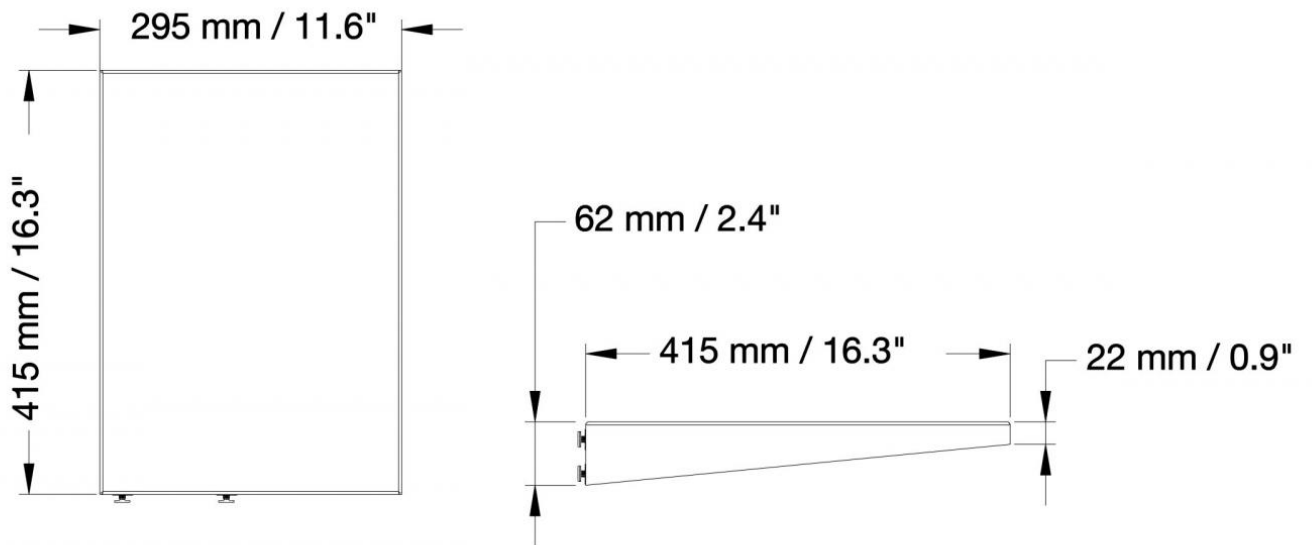

MANUFACTURER:

CONEN Produkte GmbH
 Conenstr. 4
 54497 Morbach-Gonzerath

Phone: +49 (0) 6533 75-100
 Fax: +49 (0) 6533 75-600
 E-Mail: info@conenmounts.com

Germany

www.conenmounts.com