

## LOCKABLE NOTEBOOK CABINET

FOR MOUNTING ON THE PYLON



### PRODUCT

You can easily attach this lockable laptop or notebook cabinet to the pylon column in just a few easy steps. Protect your laptop against unauthorized access and theft.

### FEATURES

- Outer dimensions, W/H/D 45,0 x 20,0 x 34,5 cm
- Inner dimensions, W/H/D 40,8 x 16,3 x 31,0 cm
- 2 brackets to mount at side of aluminum pylons included
- Lockable front flap, cable grommet at rear side
- 2 finishes available (black and grey)



Display mount



Projector mount



IWB mount

Item number	LAP-CAB	
Width / Height / Depth	450 mm / 200 mm / 345 mm	17.7" / 7.9" / 13.6"
Weight	9 kg	19.8 lbs
Packages	Package dimensions WxHxD	Package weight
LAP-CAB	490 x 240 x 385 mm / 19.3 x 9.4 x 15.2"	10 kg / 22 lbs

DIMENSIONS

in mm / inch

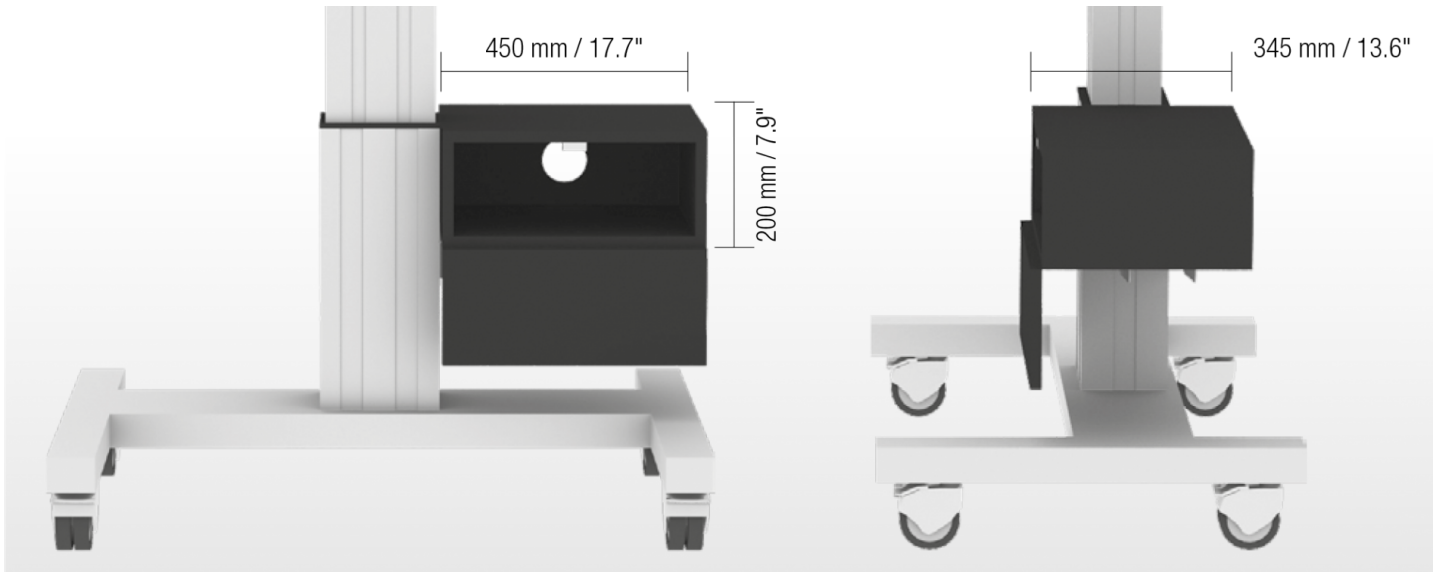

MANUFACTURER:

CONEN Produkte GmbH  
 Conenstr. 4  
 54497 Morbach-Gonzerath

Phone: +49 (0) 6533 75-100  
 Fax: +49 (0) 6533 75-600  
 E-Mail: info@conenmounts.com

Germany

[www.conenmounts.com](http://www.conenmounts.com)