



SCEXLWLB

EL. HEIGHT ADJUSTABLE SYSTEM FOR WALL MOUNTING

Factory:

Conen Produkte GmbH & Co. KG
Conenstr. 4
54497 Morbach-Gonzerath
Germany

International sales department:

Mr. Luc van der Sterren
Office: +49 65 33 75 311
Cell: +31 612 495 098
Email: Luc@conenmounts.com

Mr. Arnaud Gielen
Office: +49 6533 75 310
Cell: +49 172 655 84 61
Email: Arnaud@conenmounts.com



PRODUCT FEATURES

- ◆ Electrical height adjustable column, black anodized
- ◆ 500 mm / 19.7" height adjustment
- ◆ System suitable for wall mounting on massive walls, wall clearance by default 70 mm / 2.8", 4 leveling feet
- ◆ XL-display mount for use with 70" – 120" display
- ◆ VESA 300 x 200 up to 1200 x 600
- ◆ Maximum load approximately 150 kg / 330.7 lbs

HIGHEST POSITION

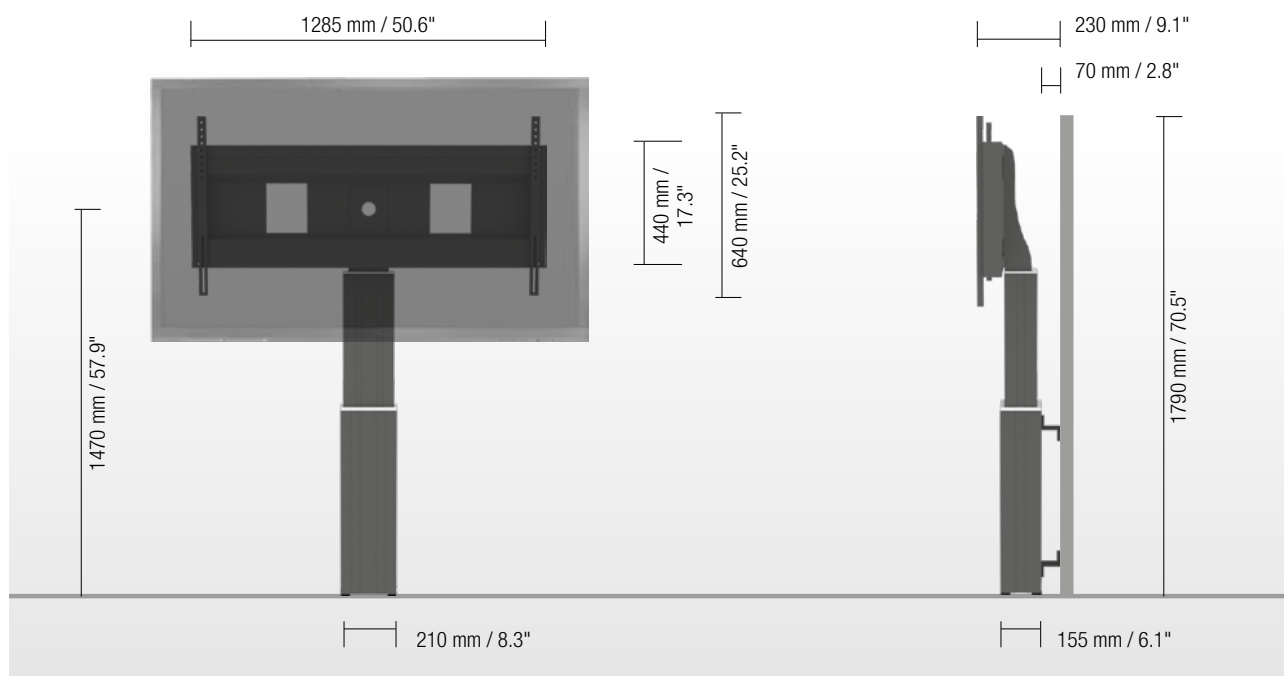

LOWEST POSITION

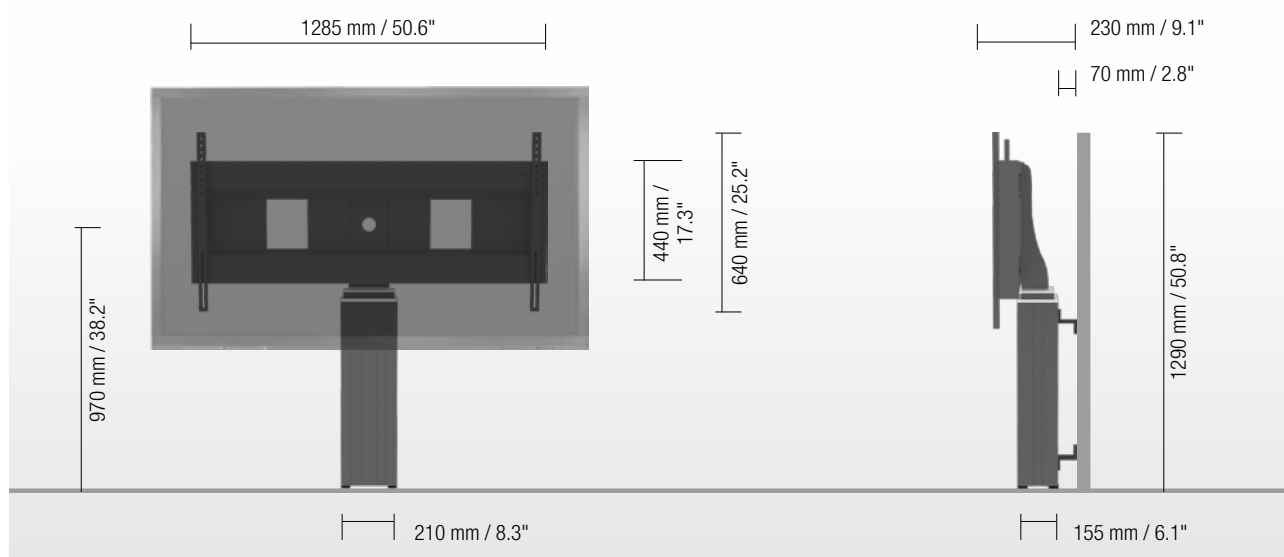

DETAIL VIEWS



Pull & release locking brackets for easier mounting of display



Leveling feet



Wired remote control

AVAILABLE ACCESSORIES



LAP4-..

Side shelf

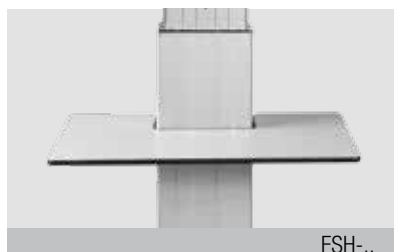

FSH-..

Front shelf



MINI-FUJI

Lockable mini PC bracket



AFSCETAKB

Keyboard shelf

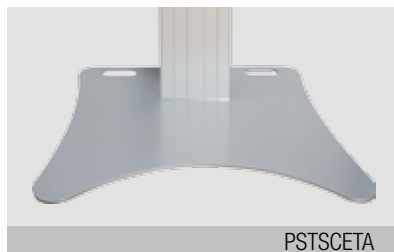

PSTSCETA

Floor plate

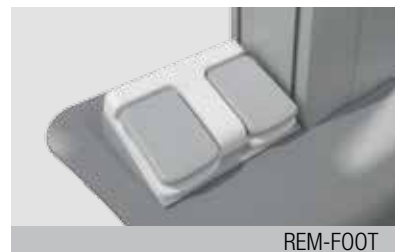

REM-FOOT

Foot remote control

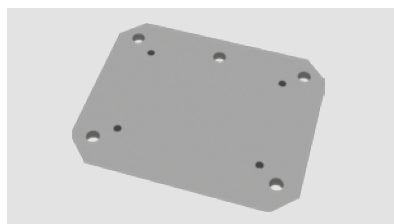

PSTSCETAS

Plate to groundfixing



CCE-EXT20

Extender (200 mm / 7.9")



SCHLIESS-VH

Display securing padlock

SIZE INDEX

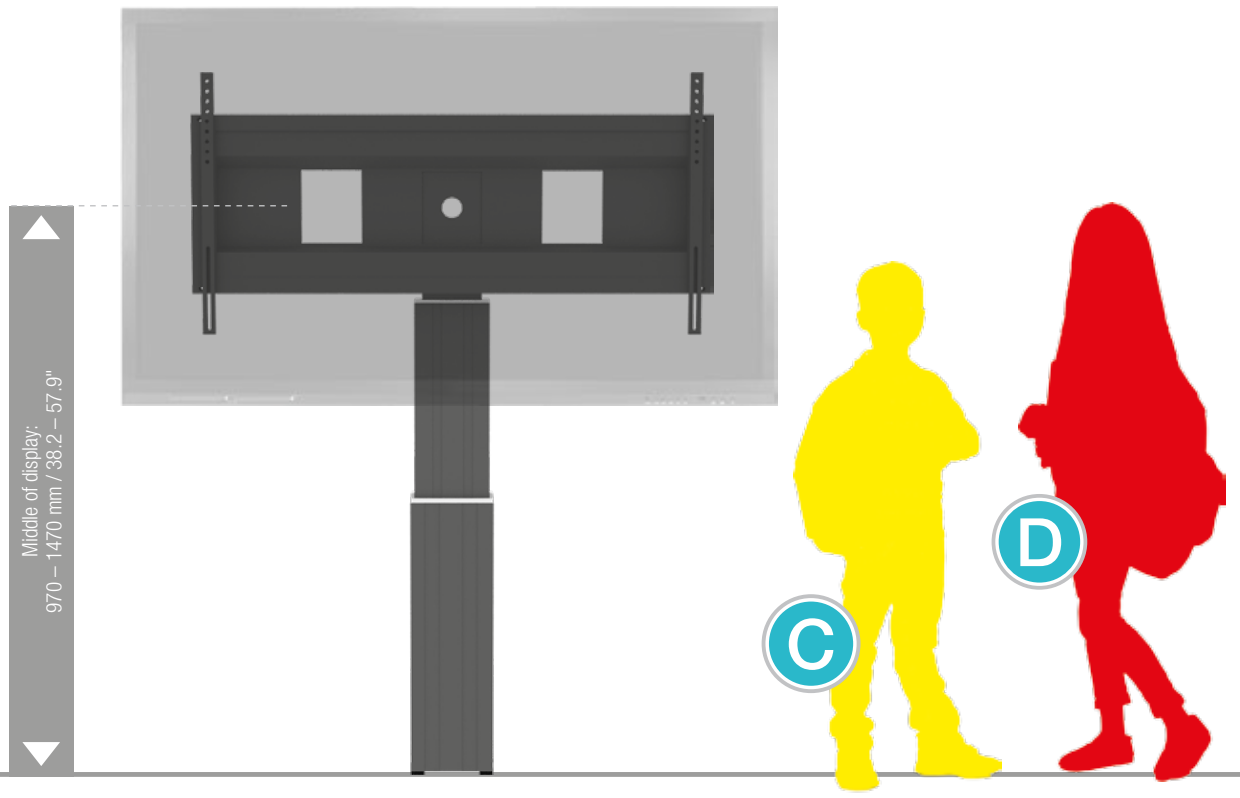

Department	Kindergarten			Primary school		Secondary school		Adults
	A	B	C	D	E	F	G	
Silhouette								
Age (years)	2 – 3	3 – 4	4 – 7	6 – 11	11 – 14	13 – 16	from 16	
Body size (mm / ")	930 – 980 37 – 38.6	1080 – 1210 42.5 – 47.6	1190 – 1420 46.9 – 56	1330 – 1590 52.4 – 62.6	1460 – 1765 57.5 – 69.5	1590 – 1880 62.6 – 74	1740 – 2070 68.5 – 81.5	
Color								

PACKING UNITS

Item no.	Description	Packing dimensions (mm / ")	Net weight (kg / lbs)	Gross weight (kg / lbs)
CCE50-WB	Electrical height adjustable column, 500 mm / 19.7" height adjustment, L = 700 mm / 27.6"	970 x 270 x 220 / 38.2 x 10.6 x 8.7	18 / 39.7	19,5 / 43
AFSCETAN12	XL-display mount	1295 x 160 x 450 / 51 x 6.3 x 17.7	15 / 33.1	18 / 39.7
Total weight			33 / 72.8	37,5 / 82.7