

TWO LARGE AND STURDY HANDLES INCLUDING LAPTOP SHELF

CONNECT TO THE DISPLAY MOUNT

PRODUCT



Large handles on each side of the display increase mobility and help protect the display in transport. A laptop shelf is included and can be mounted on the handles.

Accessories

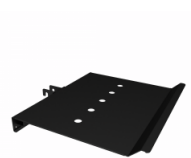

Laptop shelf



Laptop shelf

FEATURES

- > Powder coated in black
- > Set of 2 handles 1 laptop shelf
- > Assembly material for mounting of the handles to the display mount is included
- > Increase of mobility and protection of display in transport
- > Height 85 cm



Display mount



Max. load
10 kg / 22 lbs

Item number	GRIFF-SCETA	
Frame for all	55" - 86"	
Load capacity	10 kg	22 lbs
Width / Height / Depth	490 mm / 700 mm / 236 mm	19.3" / 27.6" / 9.3"
Weight	12,1 kg	26.7 lbs
Packages	Package dimensions WxHxD	Package weight
GRIFF-SCETA	720 x 250 x 480 mm / 28.3 x 9.8 x 18.9"	13,8 kg / 30.4 lbs

DIMENSIONS

in mm / inch

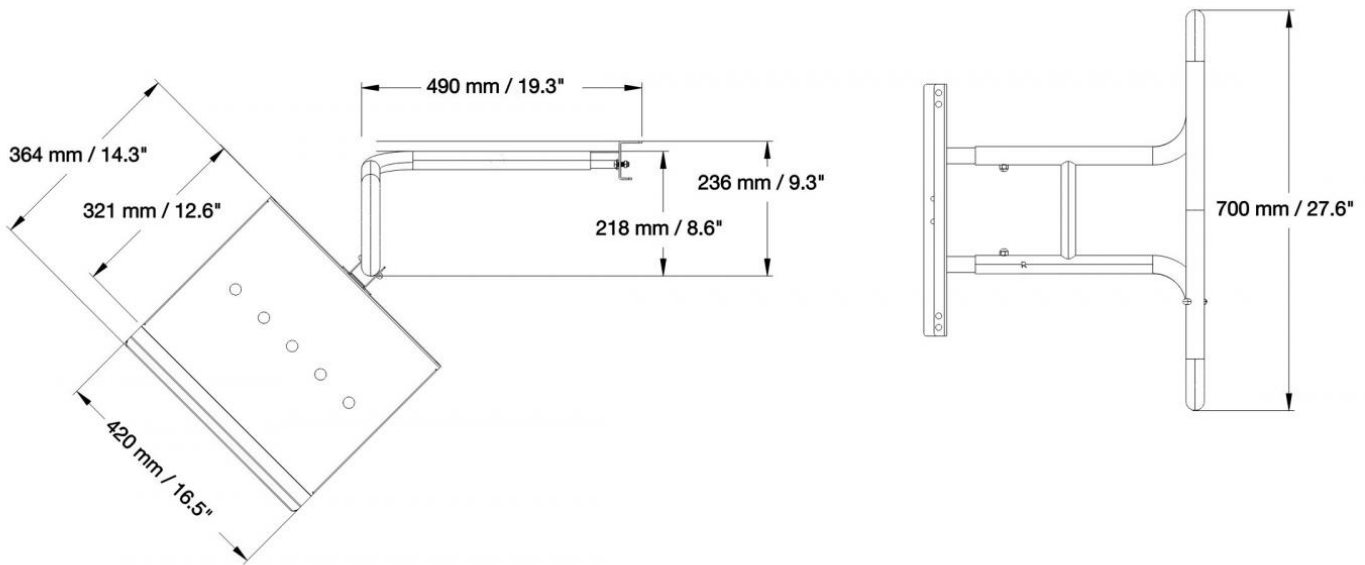

MANUFACTURER:

CONEN Produkte GmbH
 Conenstr. 4
 54497 Morbach-Gonzerath

Phone: +49 (0) 6533 75-100
 Fax: +49 (0) 6533 75-600
 E-Mail: info@conenmounts.com

Germany

www.conenmounts.com