



SCEXL

EL. HÖHENVERSTELLBARES SYSTEM MIT H-FAHRGESTELL
EL. HEIGHT ADJUSTABLE SYSTEM WITH H-MOBILE STAND

Conen Produkte GmbH & Co. KG
Conenstr. 4
54497 Morbach-Gonzerath

Germany

Tel.: +49 (0) 6533 75 - 203/ - 300
Fax: +49 (0) 6533 75 - 600
eMail: info@conen-interaktiv.de

www.conen-interaktiv.de

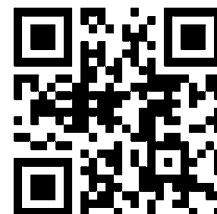

PRODUKTEIGENSCHAFTEN | PRODUCT FEATURES

- ◆ Elektrisch höhenverstellbare Pylone, natur eloxiert
 - ◆ 500 mm Hub
 - ◆ Mobiles H-Fahrgestell mit vier Schwerlastrollen, davon zwei mit Feststellbremse, RAL 9006 Weißaluminium
 - ◆ XL-Halterung zur Verwendung mit 70" – 120" Display
 - ◆ VESA 300 x 200 bis 1200 x 600
 - ◆ Maximale Belastung ca. 150 kg
- ◆ Electrical height adjustable column, natural anodized
 - ◆ 500 mm height adjustment
 - ◆ H-shaped mobile stand with four heavy duty castors – two with brakes, RAL 9006 white aluminum
 - ◆ XL-display mount for use with 70" – 120" display
 - ◆ VESA 300 x 200 up to 1200 x 600
 - ◆ Maximum load approximately 150 kg

HÖCHSTE STELLUNG | HIGHEST POSITION

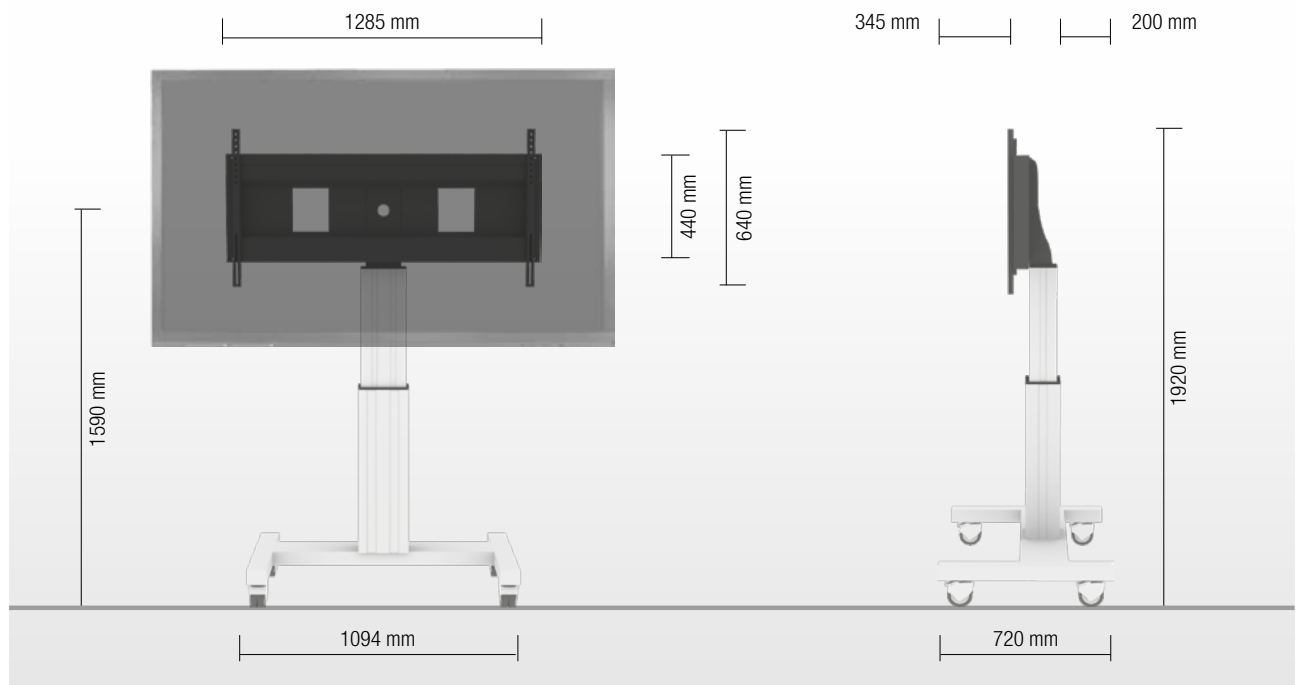

NIEDRIGSTE STELLUNG | LOWEST POSITION

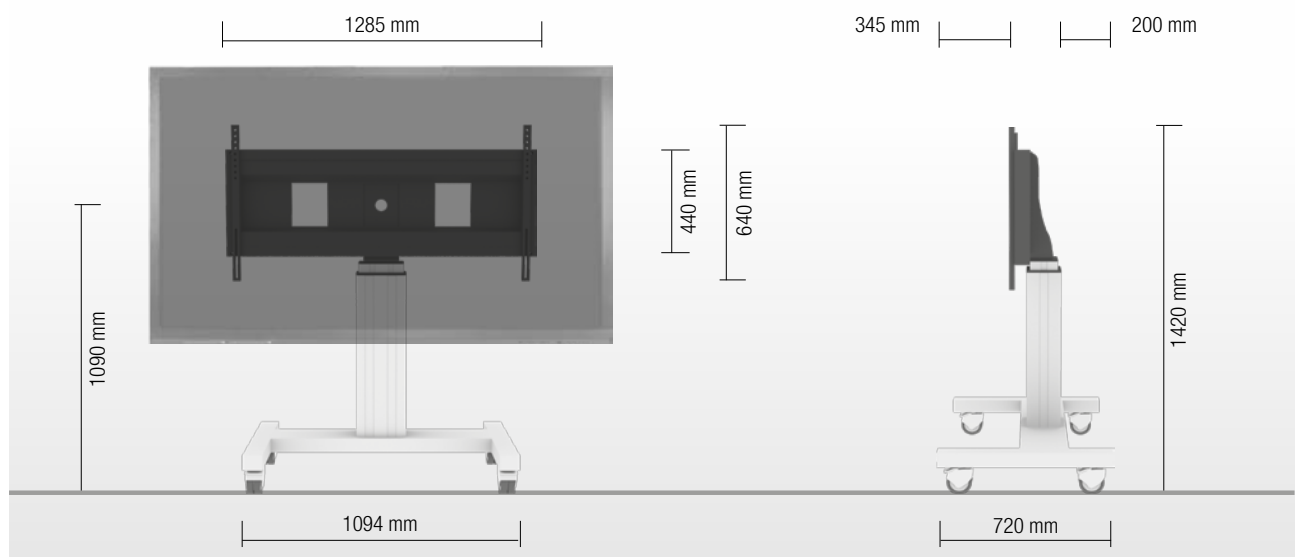

DETAILANSICHTEN | DETAIL VIEWS



Schnappklammern erleichtern die Montage
Pull & release locking brackets for easier mounting of display



Leichtlaufende, feststellbare Rollen
Smooth running & lockable castors



Elektrische Höhenverstellung
Wired remote control

WÄHLBARES ZUBEHÖR | AVAILABLE ACCESSORIES

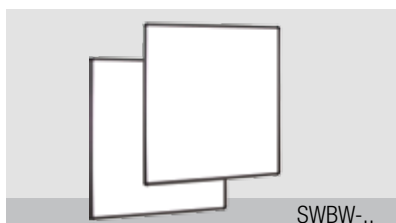

2 Whiteboard Seitenflügel
2 whiteboard side wings

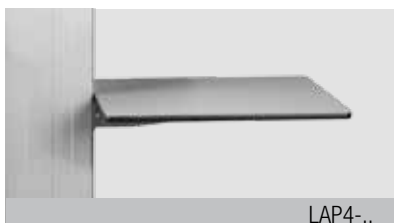

Seitentisch
Side shelf

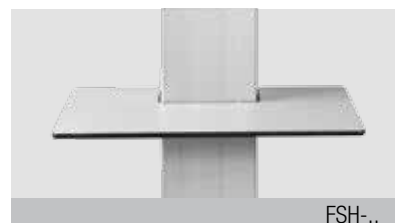

Ablagetisch
Front shelf



Abschließbare Mini-PC Halterung
Lockable mini PC bracket



Tastaturhalterung
Keyboard shelf



2 Griffe (nicht zur Verwendung mit SWBW-..)
2 Handles (not in combination with SWBW-..)



Verschließbarer Notebookschrank
Lockable notebook cabinet



Halter für Videokonferenzkameras
Video conference camera top shelf



Verlängerung (200 mm)
Extender (200 mm)

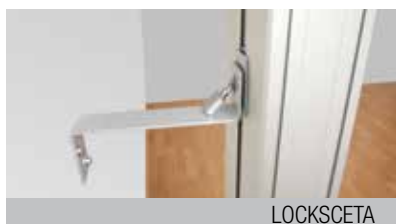

Abschließbare Wandhalterung
Lockable wall bracket



2 Boxenhalter (Boxen auf Anfrage)
2 box holders (boxes on request)



Display Sicherheitsschloss
Display securing padlock

GRÖßENINDEX | SIZE INDEX

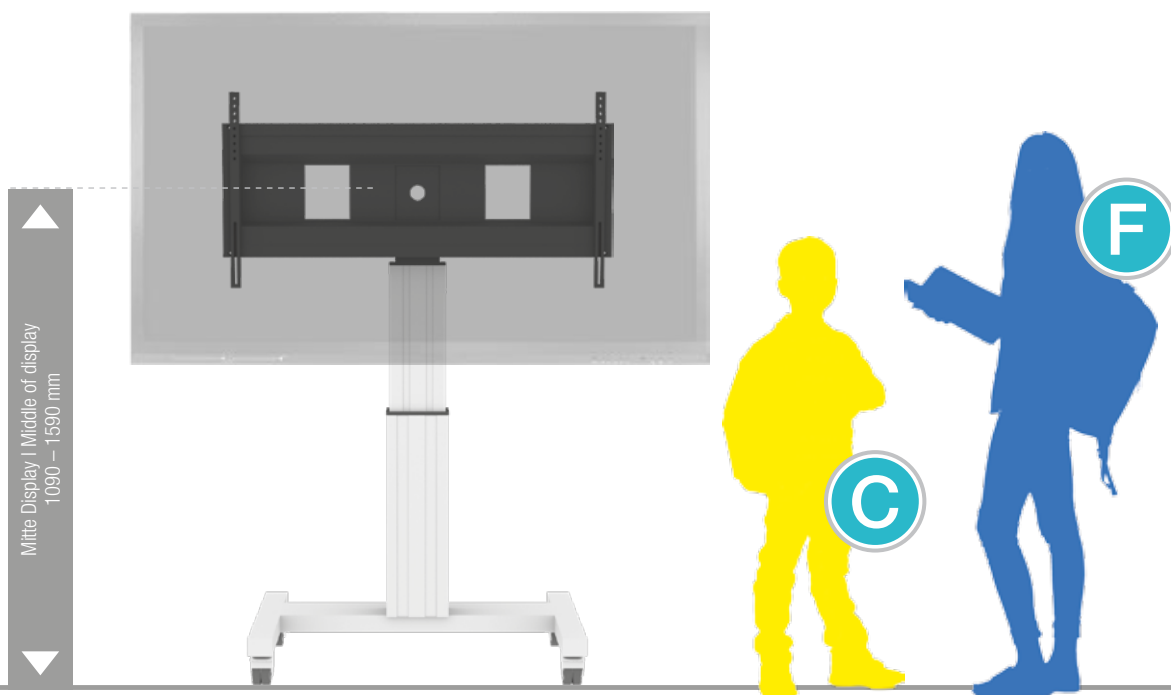

Bereich Department	Kindergarten			Grundschule Primary school		Weiterführende Schule Secondary school		Erwachsene Adults
	A	B	C	D	E	F	G	
Silhouette Silhouette	A	B	C	D	E	F	G	
Alter (Jahre) Age (years)	2 – 3	3 – 4	4 – 7	6 – 11	11 – 14	13 – 16	ab from 16	
Körpergröße Body size (mm)	930 – 980	1080 – 1210	1190 – 1420	1330 – 1590	1460 – 1765	1590 – 1880	1740 – 2070	
Farbe Colour	Green	Purple	Yellow	Red	Green	Blue		

PACKEINHEITEN | PACKING UNITS

Artikel-Nr. Item no.	Beschreibung Description	Packmaße Packing dimensions (mm)	Nettogewicht Net weight (kg)	Bruttogewicht Gross weight (kg)
CCE-50	Elektrisch höhenverstellbare Pylone, 500 mm Hub, L = 700 mm Electrical height adjustable column, 500 mm height adjustment, L = 700 mm	970 x 270 x 220	18	19,5
AFSCETAN12	XL-Display Halterung XL-display mount	1295 x 160 x 450	15	18
MST-SCETA	H-Fahrgestell H-shaped mobile stand	1140 x 780 x 150	20,7	24,2
Gesamtgewicht Total weight			53,7	61,7