



SCEXLP

EL. HEIGHT ADJUSTABLE SYSTEM WITH FLOOR PLATE

Factory:

Conen Produkte GmbH & Co. KG
Conenstr. 4
54497 Morbach-Gonzerath
Germany

International sales department:

Mr. Luc van der Sterren
Office: +49 65 33 75 311
Cell: +31 612 495 098
Email: Luc@conenmounts.com

Mr. Arnaud Gielen
Office: +49 6533 75 310
Cell: +49 172 655 84 61
Email: Arnaud@conenmounts.com



PRODUCT FEATURES

- ◆ Electrical height adjustable column, natural anodized
- ◆ 500 mm / 19.7" height adjustment
- ◆ Floor plate made of 8 mm / 0.3" strong steel, powder-coated, RAL 9006 white aluminum
- ◆ XL-display mount for use with 70" – 120" display
- ◆ VESA 300 x 200 up to 1200 x 600
- ◆ Maximum load approximately 150 kg / 330.7 lbs
- ◆ Incl. wall brackets (70 mm / 2.8")

HÖCHSTE STELLUNG | HIGHEST POSITION

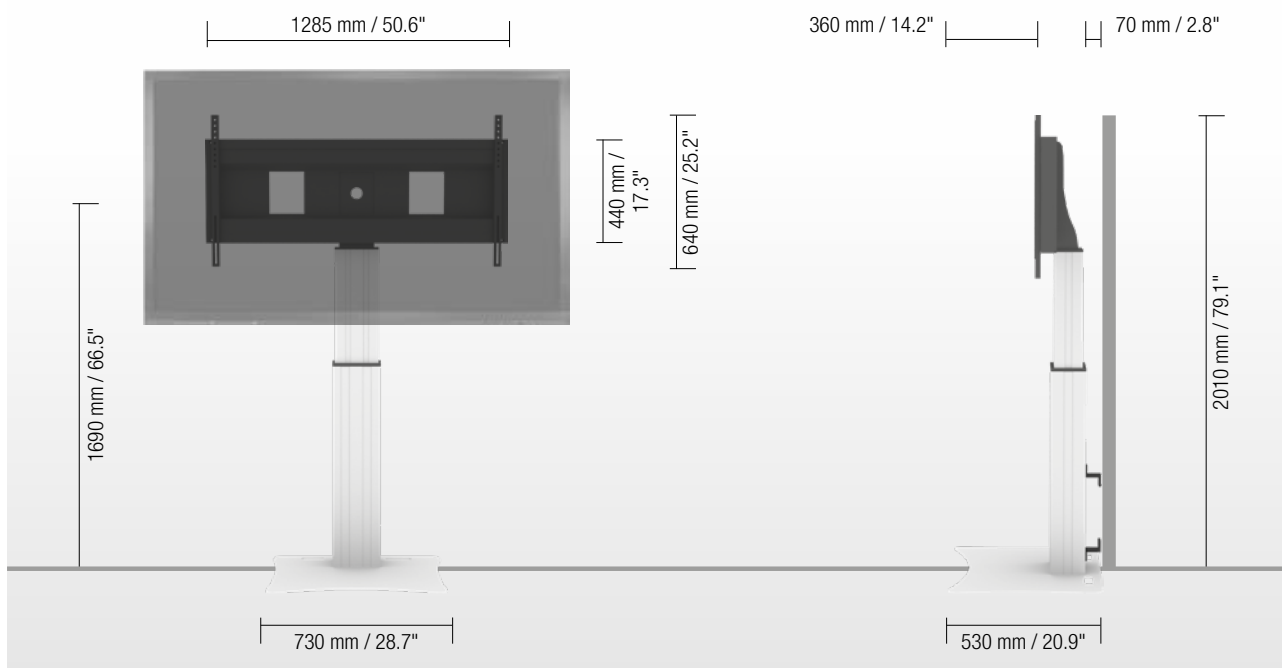

NIEDRIGSTE STELLUNG | LOWEST POSITION

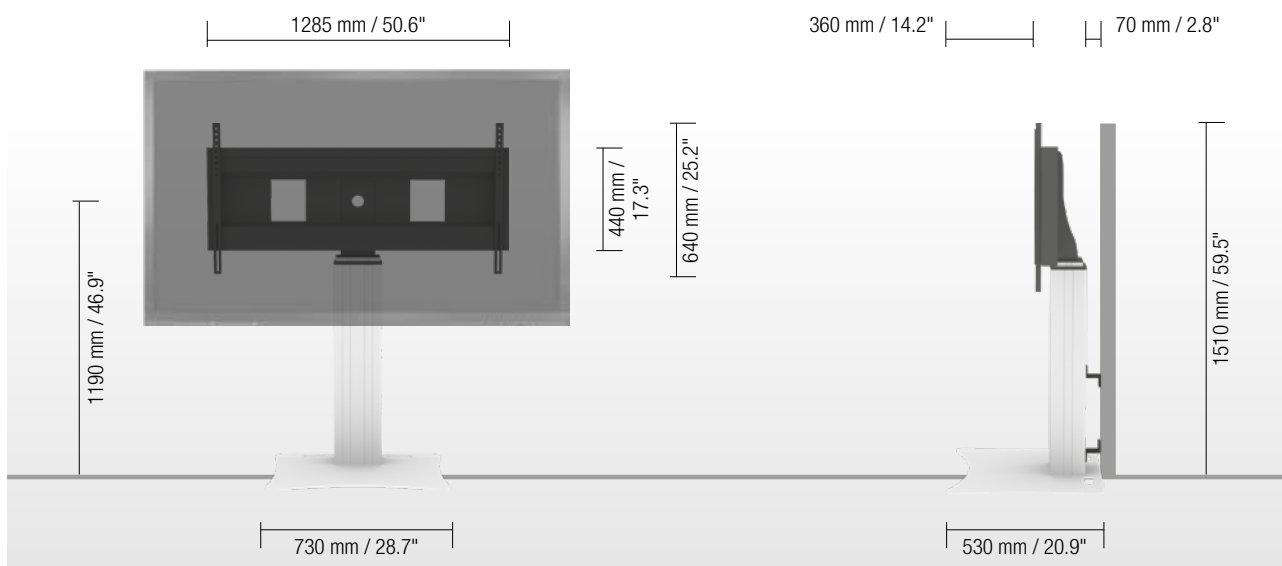

DETAIL VIEWS



Pull & release locking brackets for easier mounting of display

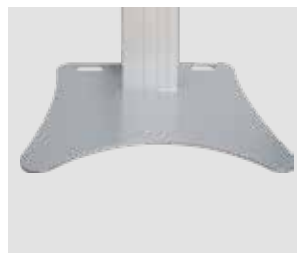

Floor plate



Wired remote control

AVAILABLE ACCESSORIES

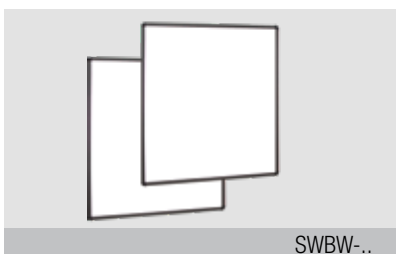

SWBW-..

2 whiteboard side wings



LAP4-..

Side shelf

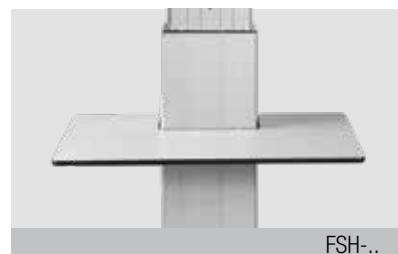

FSH-..

Front shelf



MINI-FUJI

Lockable mini PC bracket



AFSCETAKB

Keyboard shelf



VCTSCETA

Video conference camera top shelf



REM-FOOT

Foot remote control



CCE-EXT20

Extender (200 mm / 7.9")

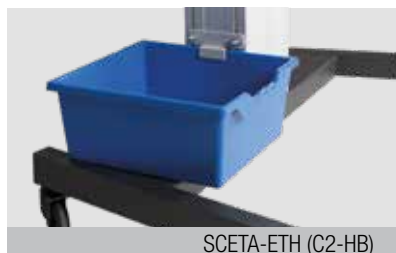

SCETA-ETH (C2-HB)

2 box holders (boxes on request)



SCHLIESS-VH

Display securing padlock

SIZE INDEX

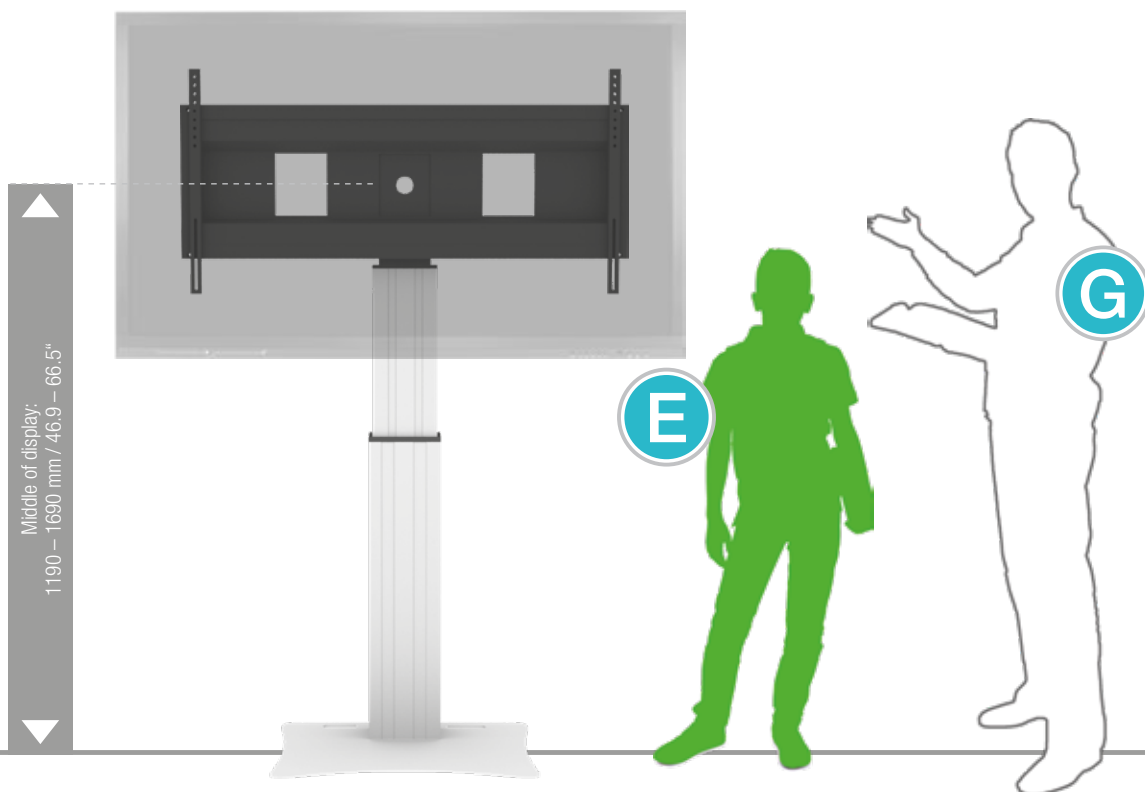

Department	Kindergarten			Primary school		Secondary school		Adults
Silhouette	A	B	C	D	E	F	G	
Age (years)	2 – 3	3 – 4	4 – 7	6 – 11	11 – 14	13 – 16	from 16	
Body size (mm / ")	930 – 980 37 – 38.6	1080 – 1210 42.5 – 47.6	1190 – 1420 46.9 – 56	1330 – 1590 52.4 – 62.6	1460 – 1765 57.5 – 69.5	1590 – 1880 62.6 – 74	1740 – 2070 68.5 – 81.5	
Color								

PACKING UNITS

Item no.	Description	Packing dimensions (mm / ")	Net weight (kg / lbs)	Gross weight (kg / lbs)
CCE70-W	Electrical height adjustable column, 500 mm / 19.7" height adjustment, L = 900 mm / 35.4"	1180 x 270 x 200 / 46.5 x 10.7 x 7.9	21 / 46.3	23,1 / 50.9
AFSCETAN12	XL-display mount	1295 x 160 x 450 / 51 x 6.3 x 17.7	15 / 33.1	18 / 39.7
PSTSCETA	Bodenplatte I Floor plate	20 x 750 x 570 / 0.8 x 29.5 x 22.4	21 / 46.3	21,8 / 48.1
Total weight			57 / 125.7	62,9 / 138.7